

BY-2 轴套 Cylindrical bushes (内径I.DØ10~Ø60)

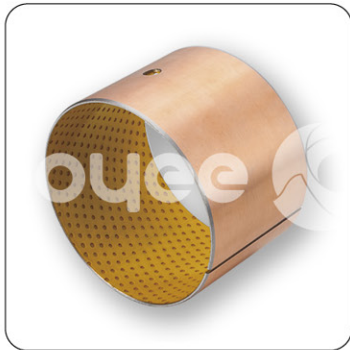

请从适用的内径、外径、长度中选择零件号
(例)内径15mm、长度10mm的情况下

BY-2 - 1510

请指定上述零件号

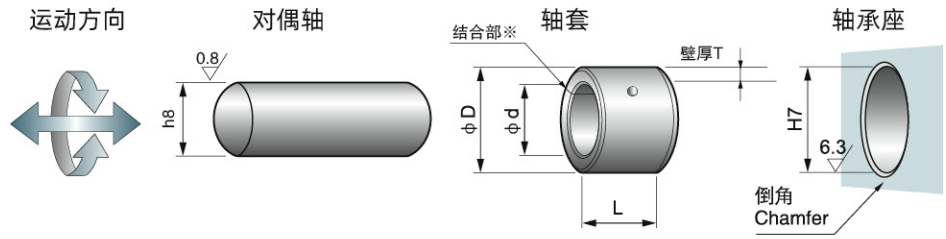

※结合部对于轴旋转没有影响，但尽量避免安装在负荷大的部位处压入。

单位Unit: mm

轴 shaft		座孔 housing		内径	外径	壁厚	油孔	长度 L $^{0}_{-0.40}$					
h8		H7		Ø d	Ø D	T	h-Ø	10	12	15	20	25	30
10	$\begin{smallmatrix} 0 \\ -0.022 \end{smallmatrix}$	12	$\begin{smallmatrix} +0.018 \\ 0 \end{smallmatrix}$	10	12	$\begin{smallmatrix} 0.980 \\ 0.955 \end{smallmatrix}$	4	1010	1012	1015	1020		
12	$\begin{smallmatrix} 0 \\ -0.027 \end{smallmatrix}$	14	"	12	14	"	"	1210	1212	1215	1220	1225	
14	"	16	"	14	16	"	"			1415	1420	1425	
15	"	17	"	15	17	"	"	1510	1512	1515		1525	
16	"	18	"	16	18	"	"			1615	1620	1625	
18	"	20	$\begin{smallmatrix} +0.021 \\ 0 \end{smallmatrix}$	18	20	"	"			1815	1820	1825	
20	$\begin{smallmatrix} 0 \\ -0.033 \end{smallmatrix}$	23	"	20	23	$\begin{smallmatrix} 1.475 \\ 1.445 \end{smallmatrix}$	"			2015	2020	2025	2030
22	"	25	"	22	25	"	6			2215	2220	2225	2230
24	"	27	"	24	27	"	"			2415	2420	2425	2430
25	"	28	"	25	28	"	"			2515	2520	2525	2530
28	"	32	$\begin{smallmatrix} +0.025 \\ 0 \end{smallmatrix}$	28	32	$\begin{smallmatrix} 1.970 \\ 1.935 \end{smallmatrix}$	"				2820	2825	2830
30	"	34	"	30	34	"	"				3020		3030
32	$\begin{smallmatrix} 0 \\ -0.039 \end{smallmatrix}$	36	"	32	36	"	"				3220		3230
35	"	39	"	35	39	"	"				3520		3530
36	"	40	"	36	40	"	"						
37	"	41	"	37	41	"	"				3720		
40	"	44	"	40	44	"	8				4020		4030
45	"	50	"	45	50	$\begin{smallmatrix} 2.460 \\ 2.415 \end{smallmatrix}$	"				4520		4530
50	"	55	$\begin{smallmatrix} +0.030 \\ 0 \end{smallmatrix}$	50	55	"	"						
55	$\begin{smallmatrix} 0 \\ -0.046 \end{smallmatrix}$	60	"	55	60	"	"				5520		
60	"	65	"	60	65	"	"						

BY-2 轴套 Cylindrical bushes (内径I.DØ10~Ø60)

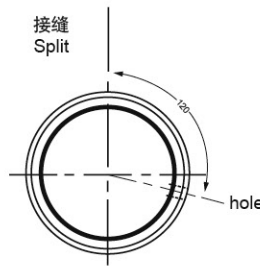
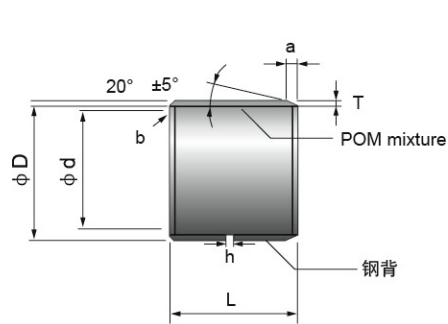

a:外径倒角 内径Ø10以上(mm)

T	1.0	1.5	2.0
a	0.5	0.8	1.0

b:内径倒角 内径Ø10以上(mm)

T	1.0	1.5	2.0
b	C0.3	C0.5	C0.5

※内径Ø10不到的内外径倒角去除毛刺程度即可。

单位Unit: mm

长度 L _{0.040}									内径
35	40	50	60	70	80	100	110	120	Ø d
									10
									12
									14
									15
									16
									18
									20
									22
									24
									25
									28
	3040								30
3235	3240								32
3535		3550							35
									36
									37
	4040	4050							40
	4540	4550							45
	5040	5050	5060						50
	5540	5550	5560						55
	6040		6060	6070					60

BY-2 轴套 Cylindrical bushes (内径I.DØ65~Ø300)

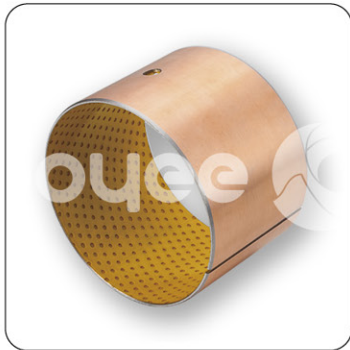

请从适用的内径、外径、长度中选择零件号
(例)内径60mm、长度50mm的情况下

BY-2 - 6050

请指定上述零件号

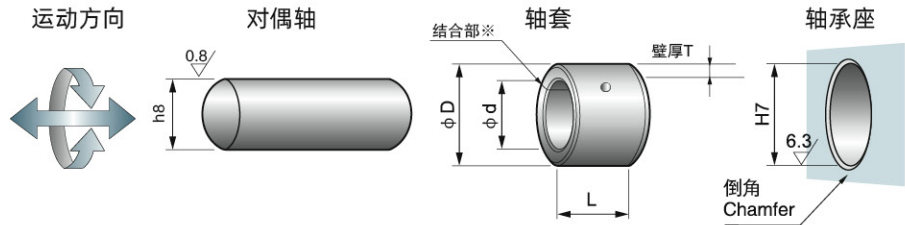

※结合部对于轴旋转没有影响，但尽量避免安装在负荷大的部位处压入。

单位Unit: mm

轴 shaft		座孔housing		内径	外径	壁厚	油孔	长度 L $^{0}_{-0.40}$					
h8		H7		Ø d	Ø D	T	h-Ø	30	40	50	60	65	70
65	$^{0}_{-0.046}$	70	$^{+0.030}_{0}$	65	70	$^{2.460}_{2.415}$	8	6530	6540	6550	6060		6570
70	"	75	"	70	75	"	"		7040	7050		7065	7070
75	"	80	"	75	80	"	"		7540		7560		
80	"	85	$^{+0.035}_{0}$	80	85	$^{2.450}_{2.385}$	9.5				8060		
85	$^{0}_{-0.054}$	90	"	85	90	"	"	8530	8540		8560		
90	"	95	"	90	95	"	"		9040		9060		
95	"	100	"	95	100	"	"				9560		
100	"	105	"	100	105	"	"			10050	10060		
105	"	110	"	105	110	"	"				10560		
110	"	115	"	110	115	"	"				11060		
115	"	120	"	115	120	"	"						11570
120	"	125	$^{+0.040}_{0}$	120	125	"	"				12060		
125	$^{0}_{-0.063}$	130	"	125	130	"	"				12560		
130	"	135	"	130	135	"	"			13050	13060		
135	"	140	"	135	140	"	"			13550	13560		
140	"	145	"	140	145	"	"				14060		
150	"	155	"	150	155	"	"			15050	15060		
160	"	165	"	160	165	"	"			16050	16060		
170	"	175	"	170	175	"	"			17050	17060		
180	"	185	$^{+0.046}_{0}$	180	185	"	"			18050	18060		
190	$^{0}_{-0.072}$	195	"	190	195	"	"			19050	19060		
200	"	205	"	200	205	"	"			20050	20060		
220	"	225	"	220	225	"	"			22050	22060		
240	"	245	"	240	245	"	"			24050	24060		
250	"	255	$^{+0.052}_{0}$	250	255	"	"			25050	25060		
260	$^{0}_{-0.081}$	265	"	260	265	"	"			26050	26060		
280	"	285	"	280	285	"	"			28050	28060		
300	"	305	"	300	305	"	"			30050	30060		

BY-2 轴套 Cylindrical bushes (内径I.D.Ø65~Ø300)

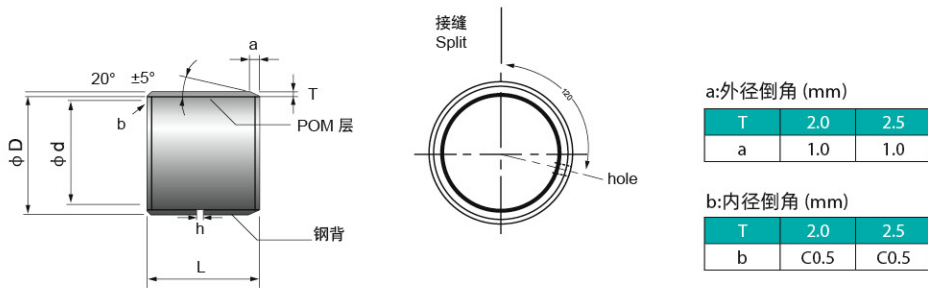

单位Unit: mm

长度 L ₃₄₀							内径
80	90	95	100	110	115	120	Ø d
							65
7080							70
7580							75
8080				80110			80
8580			85100	85110			85
9080	9090		90100	90110			90
				95110			95
10080		10095			100115		100
					105115		105
				110110	110115		110
							115
			120100	120110			120
			125100	125110			125
13080			130100				130
13580							135
14080			140100				140
15080			150100				150
16080			160100				160
17080			170100				170
18080			180100				180
19080			190100			190120	190
20080			200100			200120	200
22080			220100			220120	220
24080			240100			240120	240
25080			250100			250120	250
26080			260100			260120	260
28080			280100			280120	280
30080			300100			300120	300